

1. Ambito de aplicación

Cargas de viento en edificios hasta 60 m de altura.

2. Zona eólica

Se determina por las coordenadas geográficas del emplazamiento en el mapa adjunto.

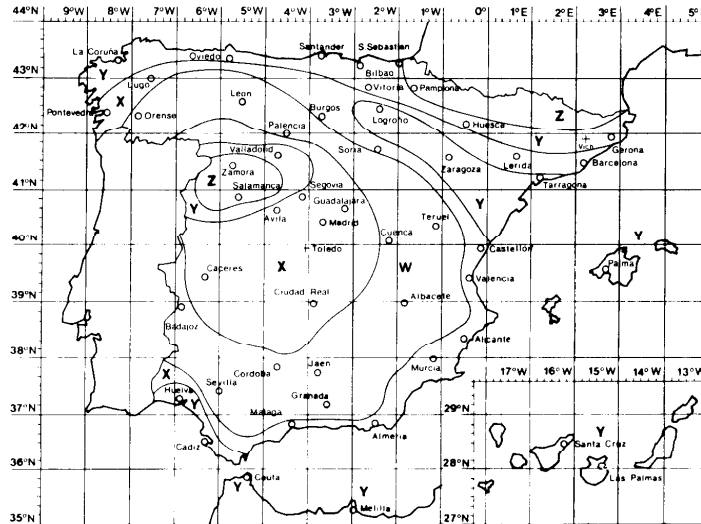

3. Carga total de viento sobre edificios

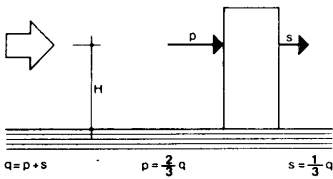

Para edificios de planta rectangular o combinación de rectángulos, se considerará una presión p a barlovento y una succión s a sotavento, sobre cada metro cuadrado de la fachada del edificio, cuya suma q se obtiene en la Tabla I, en función de la altura H sobre el nivel del suelo, de la zona eólica y de la situación topográfica del emplazamiento del edificio. Se considera situación topográfica expuesta: las costas, cumbres de montaña, desfiladeros, bordes de meseta y aquellos lugares en que puedan preverse vientos locales de intensidad excepcional.

Para el cálculo de la carga sobre acristalamientos u otras superficies en que pueda haber huecos abiertos se tomará el valor q .

Tabla 1

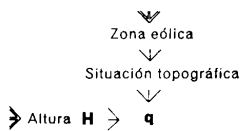

Carga total de viento q en kg/m^2

Zona eólica	W		X		Y		Z		
	Normal	Expuesta	Normal	Expuesta	Normal	Expuesta	Normal	Expuesta	
Situación topográfica	60	100	110	111	122	123	135	136	149
	57	99	109	110	121	122	134	135	148
	54	98	108	109	120	121	133	134	147
	51	97	107	108	119	120	132	132	146
	48	96	106	107	118	119	131	131	144
	45	95	105	106	117	118	129	130	143
	42	94	104	105	116	116	128	128	141
	39	92	102	103	114	114	126	126	138
	36	91	100	102	112	113	124	124	137
	33	90	99	101	111	112	123	123	135
Altura H en m sobre el nivel del suelo	30	89	98	100	110	110	121	122	134
	27	88	96	98	107	109	119	120	131
	24	86	95	96	106	107	117	118	129
	21	84	92	93	103	104	114	114	125
	18	81	89	90	99	100	110	110	121
	15	76	83	84	93	94	103	103	114
	12	71	78	79	87	88	96	97	106
	9	65	72	73	80	81	89	89	97
	6	60	66	67	74	74	82	82	90
	3	53	59	60	66	66	73	73	80

4. Carga de viento sobre cubiertas

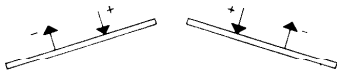

Los valores de la carga del viento en kg/m^2 sobre cada plano de cubiertas: m a barlovento y n a sotavento, se obtienen para cada dirección del viento en la Tabla 2 para el caso de edificación cerrada por muros, con o sin huecos, y en las Tablas 3 y 4 para el caso de edificación abierta con libre paso de viento a su través.

En ambos casos el signo $+$ indica que la componente vertical de la carga tiene el sentido de una acción gravitatoria y el signo $-$ el sentido contrario.

En los casos en que figuran dos hipótesis de carga, se obtendrán los esfuerzos derivados de ambas para cada dirección del viento, y se dimensionará cada elemento estructural con el que resulte más desfavorable.

Tabla 2

Carga de viento sobre cubiertas en edificación cerrada

Zona eólica		Situación topográfica		Altura H en m sobre el nivel del suelo								
W	Normal	Normal	Normal	3	9	23	57	60				
x	Expuesta	Normal	Expuesta	>	6	14	24	55	60	60		
y	Normal	Normal	Expuesta	>	3	9	15	25	50	60	60	60
Z	Expuesta	Normal	Expuesta	>	6	9	15	24	40	60	60	60
				>	3	7	11	15	20	30	60	60

Tipo de edificación		Tipo de edificación		Tipo de edificación		
Sin huecos		Con menos del 33 % de huecos		Con más del 33 % de huecos		
	α°	α°	α°	α°	α°	
	0	0	0	0	0	
	10	-10	-13	-16	-18	-20
	20	0	0	0	0	0
	30	+10	+13	+16	+18	+20
	40	+21	+26	+31	+35	+39
	50	+31	+38	+47	+53	+59
	60	+41	+51	+63	+71	+79
	90	+41	+51	+63	+71	+79
	n	-21	-26	-31	-35	-39
	α°	α°	α°	α°	α°	
	0	-10	-13	-16	-18	-20
	10	0	0	0	0	0
	20	+10	+13	+16	+18	+20
	30	+21	+26	+31	+35	+39
	40	+31	+38	+47	+53	+59
	50	+41	+51	+63	+71	+79
	60	+52	+64	+79	+89	+99
	90	+52	+64	+79	+89	+99
	n	10	-13	-16	-18	-20
	α°	α°	α°	α°	α°	
	0	-41	-51	-63	-71	-79
	10	-31	-38	-47	-53	-59
	20	-21	-26	-31	-35	-39
	30	-10	-13	-16	-18	-20
	40	0	0	0	0	0
	50	+10	+13	+16	+18	+20
	60	+21	+26	+31	+35	+39
	90	+21	+26	+31	+35	+39
	n	-41	-51	-63	-71	-79
	α°	α°	α°	α°	α°	
	0	0	0	0	0	
	10	+10	+13	+16	+18	+20
	20	+21	+26	+31	+35	+39
	30	+31	+38	+47	+53	+59
	40	+41	+51	+63	+71	+79
	50	+52	+64	+79	+89	+99
	60	+62	+77	+94	+106	+118
	90	+62	+77	+94	+106	+118
	n	0	0	0	0	0
	α°	α°	α°	α°	α°	
	0	-62	-77	-94	-106	-118
	10	-52	-64	-79	-89	-99
	20	-41	-51	-63	-71	-79
	30	-31	-38	-47	-53	-59
	40	-21	-26	-31	-35	-39
	50	-10	-13	-16	-18	-20
	60	0	0	0	0	0
	90	0	0	0	0	0
	n	-62	-77	-94	-106	-118

➤ Pasar a la altura inmediata superior

Tabla 3

Carga de viento sobre cubiertas en edificación abierta y doble faldón

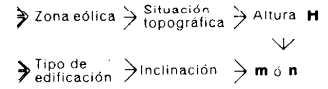

Zona eólica	Situación topográfica	Altura H en m sobre el nivel del suelo									
		3	9	23	57	60					
W	Normal	3	9	23	57	60					
	Expuesta	>	6	15	28	60					
X	Normal	>	6	14	24	55	60				
	Expuesta	>	3	9	16	28	53	60			
Y	Normal	>	3	9	15	25	50	60			
	Expuesta	>	6	6	9	15	24	40	60		
Z	Normal	>	>	6	9	15	24	40	60		
	Expuesta	>	>	3	7	11	15	20	30	60	

Tipo de edificación

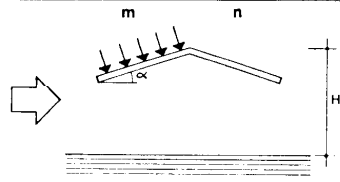

Hipotesis A

m	α°	W									
		0	10	20	30	40	50	60	90		
n	β°	0	0	0	0	0	0	0	0	0	0
		10	+41	+51	+63	+71	+79	+86	+92	+98	+106
		20	+52	+64	+79	+89	+99	+108	+116	+122	+133
		30	+62	+77	+94	+106	+118	+130	+139	+147	+160
		40	+62	+77	+94	+106	+118	+130	+139	+147	+160
		50	+62	+77	+94	+106	+118	+130	+139	+147	+160
		60	+62	+77	+94	+106	+118	+130	+139	+147	+160
		90	+62	+77	+94	+106	+118	+130	+139	+147	+160

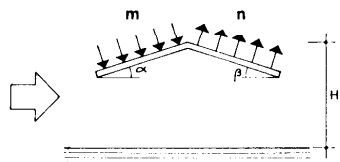

Hipotesis B

m	α°	W									
		0	10	20	30	40	50	60	90		
n	β°	0	0	0	0	0	0	0	0	0	0
		10	+10	+13	+16	+18	+20	+22	+23	+24	+27
		20	+21	+26	+31	+35	+39	+43	+46	+49	+53
		30	+21	+26	+31	+35	+39	+43	+46	+49	+53
		40	+21	+26	+31	+35	+39	+43	+46	+49	+53
		50	+31	+38	+47	+53	+59	+65	+69	+73	+80
		60	+41	+51	+63	+71	+79	+86	+92	+98	+106
		90	+41	+51	+63	+71	+79	+86	+92	+98	+106

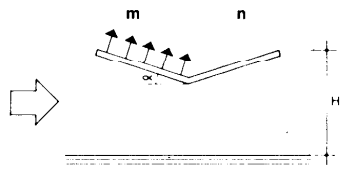

Hipotesis A

m	α°	W									
		0	10	20	30	40	50	60	90		
n	β°	0	0	0	0	0	0	0	0	0	0
		10	-41	-51	-63	-71	-79	-86	-92	-98	-106
		20	-52	-64	-79	-89	-99	-108	-116	-122	-133
		30	-62	-77	-94	-106	-118	-130	-139	-147	-160
		40	-62	-77	-94	-106	-118	-130	-139	-147	-160
		50	-62	-77	-94	-106	-118	-130	-139	-147	-160
		60	-62	-77	-94	-106	-118	-130	-139	-147	-160
		90	-62	-77	-94	-106	-118	-130	-139	-147	-160

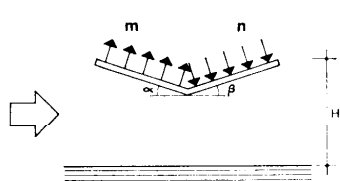

Hipotesis B

m	α°	W									
		0	10	20	30	40	50	60	90		
n	β°	0	0	0	0	0	0	0	0	0	0
		10	-10	-13	-16	-18	-20	-22	-23	-24	-27
		20	-21	-26	-31	-35	-39	-43	-46	-49	-53
		30	-21	-26	-31	-35	-39	-43	-46	-49	-53
		40	-21	-26	-31	-35	-39	-43	-46	-49	-53
		50	-31	-38	-47	-53	-59	-65	-69	-73	-80
		60	-41	-51	-63	-71	-79	-86	-92	-98	-106
		90	-41	-51	-63	-71	-79	-86	-92	-98	-106

→ Pasar a la altura inmediata superior

Tabla 4

Carga de viento sobre cubiertas en edificación abierta y faldón único

Zona eólica	Situación topográfica	Altura H en m sobre el nivel del suelo									
		3	9	23	57	60					
W	Normal Expuesta	>	6	15	28	60					
X	Normal Expuesta	>	3	9	16	28	53	60			
Y	Normal Expuesta	>	>	6	9	15	24	40	60		
Z	Normal Expuesta	>	>	3	7	11	15	20	30	60	

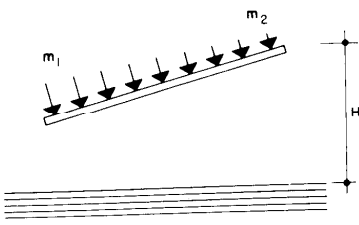
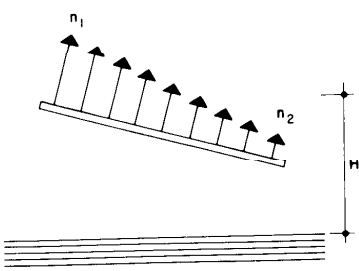
Zona eólica	Situación topográfica	Tipo de edificación	Inclinación	m ó n	Tipo de edificación	Altura H en m sobre el nivel del suelo															
						3	9	23	57	60											
W	Normal Expuesta	m ₁ m ₂	α°	m ₁ m ₂		0	0	0	0	0	0	0	0	0	0	0					
						10	+41	+51	+63	+71	+79	+86	+92	+98	+106						
						20	+62	+77	+94	+106	+118	+130	+139	+147	+160						
						30	+83	+102	+126	+142	+158	+173	+185	+196	+213						
						40	+83	+102	+126	+142	+158	+173	+185	+196	+213						
						50	+73	+90	+110	+124	+138	+151	+162	+171	+186						
						60	+62	+77	+94	+106	+118	+130	+139	+147	+160						
						90	+62	+77	+94	+106	+118	+130	+139	+147	+160						
						X	Normal Expuesta	n ₁ n ₂	α°	n ₁ n ₂		0	0	0	0	0	0	0	0	0	0
						10						-41	-51	-63	-71	-79	-86	-92	-98	-106	
						20						-62	-77	-94	-106	-118	-130	-139	-147	-160	
						30						-83	-102	-126	-142	-158	-173	-185	-196	-213	
40	-83	-102	-126	-142	-158	-173						-185	-196	-213							
50	-73	-90	-110	-124	-138	-151						-162	-171	-186							
60	-62	-77	-94	-106	-118	-130						-139	-147	-160							
90	-62	-77	-94	-106	-118	-130						-139	-147	-160							

> Pasar a la altura inmediata superior

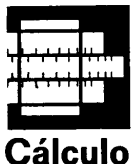

5. Ejemplos

Carga total de viento sobre edificios

Datos	Tabla	Resultado
Hospital en Vich (41° 55' N, 2° 15' E)		Zona edifica Y
Situación topográfica: Normal		
Planta 12: H = 37 m	1	$q_{12} = 113 \text{ kg/m}^2$

Fuerza horizontal en la planta 12 del Pórtico AB

$F_{12} = 3 \times 4 \times 114 = 1368 \text{ kg} = 1,4 \text{ t}$

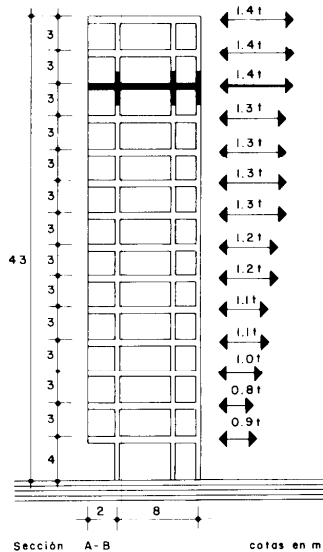
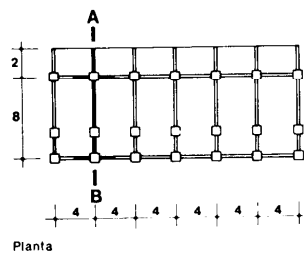

Carga de viento sobre cubiertas

Datos	Tabla	Resultado
Nave industrial en Toledo: (39° 51' N, 4° 1' W)		Zona eólica X
Situación topográfica: Normal		
Altura de cubierta: 6 m		
Inclinación de la cubierta: Faldón a-b = 20° Faldón b-c = 40°		
Tipo de edificación: cerrada con menos del 33% de huecos		
Carga:	2	Viento hacia la derecha
		Hipótesis A: Faldón a-b m = + 13 kg/m ² Faldón b-c n = - 13 kg/m ²
		Hipótesis B: Faldón a-b m = - 26 kg/m ² Faldón b-c n = - 51 kg/m ²
	2	Viento hacia la izquierda
		Hipótesis A: Faldón a-b n = - 13 kg/m ² Faldón b-c m = + 38 kg/m ²
		Hipótesis D: Faldón a-b n = - 51 kg/m ² Faldón b-c m = 0 kg/m ²

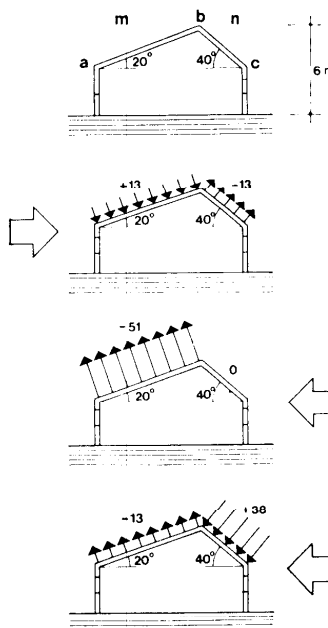

Se dimensionarán todos los elementos estructurales de la cercha para resistir la peor de las sollicitaciones deducidas de los cuatro estados de carga.